

# Veraview X800



Thinking ahead. Focused on life.



# Veraview X800

## The New Frontier for Dental Imaging

The Veraview X800 is an all-in-one dental X-ray unit that produces stunning images for panoramic, cephalometric, and CBCT evaluation.

High resolution, this unit offers a minute voxel size of just 80  $\mu\text{m}$  and features a horizontal X-ray beam for artifact reduction. Two exposure modes offer control and flexibility with a 360° high definition scan, or a faster 180° rotation with reduced dose. With a range of image sizes and unique features, the Veraview X800 has reached the pinnacle of dental imaging technology.





# High Resolution Images

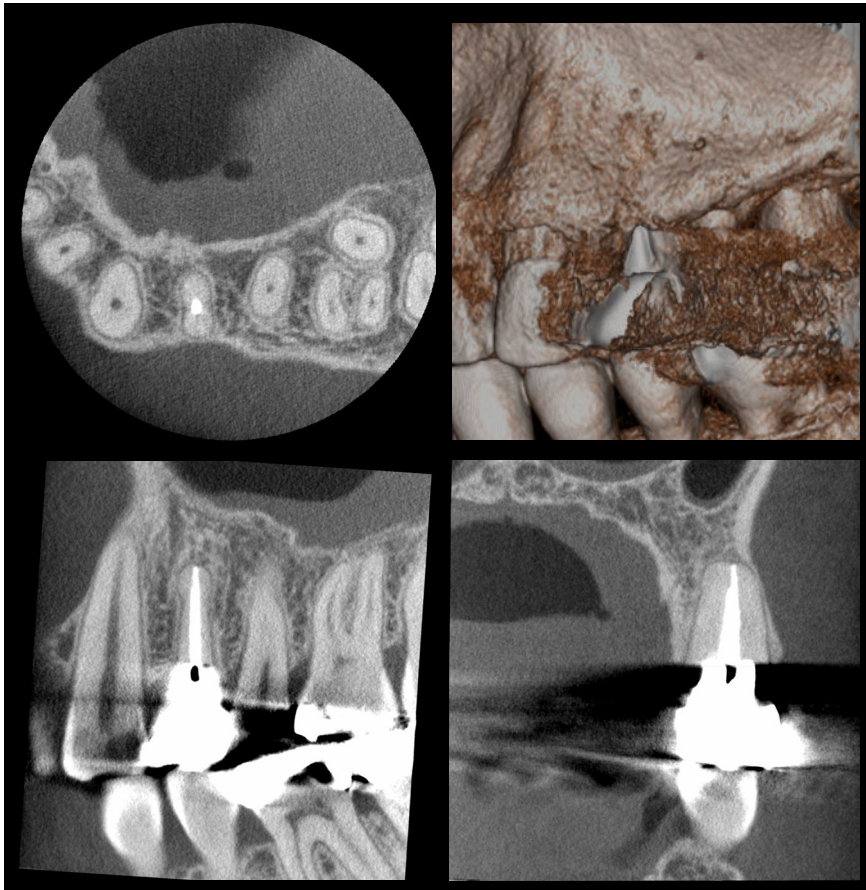

Ø 40 x H 40 mm High resolution (80 μm)



High resolution (80μm)



Standard resolution (125 μm\*\*)

## High-resolution, limited-field CBCT Imaging

For FOV Ø40 × H40 exposures, the voxel size is 80 μm and resolution is 2.5 LP/mm. As shown in the examples above, artifacts are reduced using 80 μm as compared to 125 μm voxels.

\*Spatial resolution indicates how small objects can be and still be discriminated visually. This is called spatial frequency and is usually expressed as “line pairs per millimeter (LP/mm)”. This indicates how many pairs of white and black lines can be discriminated within 1 millimeter; the higher the number, the greater the resolution. MTF (Modulation Transfer Function) is one way to objectively evaluate the line-pair resolution and objectively expresses how many line-pairs and at what level of contrast can be discriminated. Generally, if MTF is 10%, naked eye discrimination is possible. Spatial resolution does not depend only on voxel size.

\*\*Veraviewepocs 3D Series

Spatial resolution\*

MTF (%)

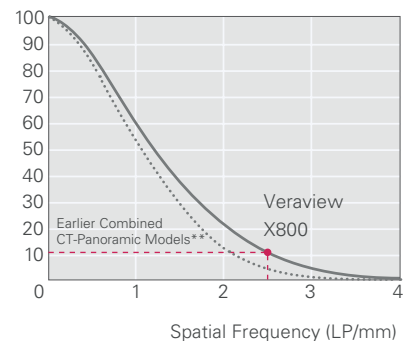

# Horizontal X-ray Beam



## Horizontal X-ray Beam for Minimal Artifacts

For CBCT exposures, the x-ray beam is horizontal during emission which minimizes artifacts and reduces distortion.

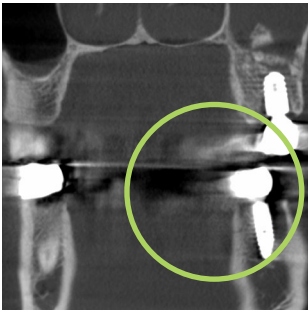

CBCT Image (horizontal beam)

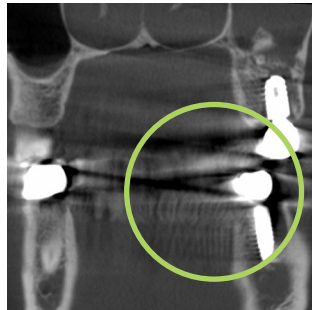

Veriviewpocs 3D series Image (Raised Beam)

## Adjustable for Panoramic Exposures

By shifting the Flat Panel Detector (FPD), the angle of the X-ray beam can be adjusted from horizontal (for CBCT exposures) up to 5° for panoramic exposures. This slight adjustment suppresses the hard palate during a panoramic and ensures high quality for both image types.

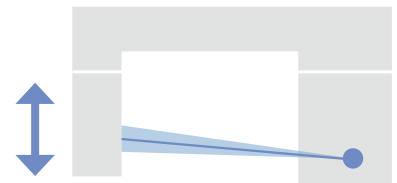

# 360° Scan

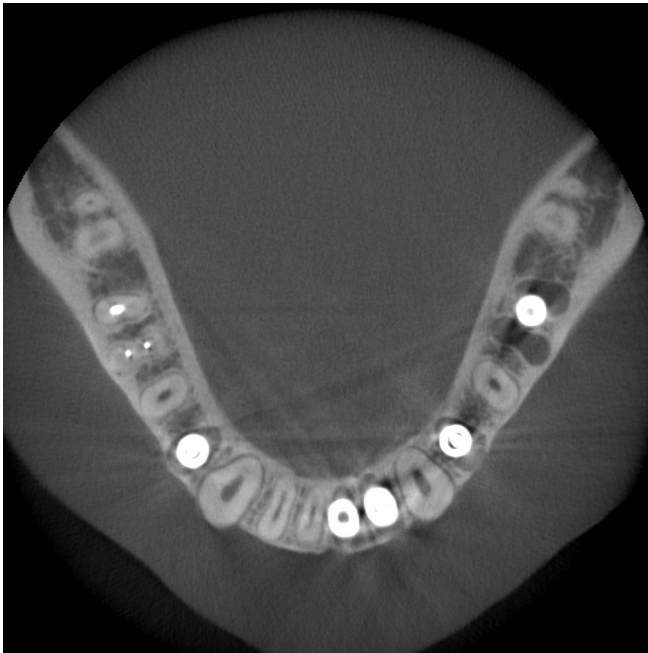

360° Mode Image

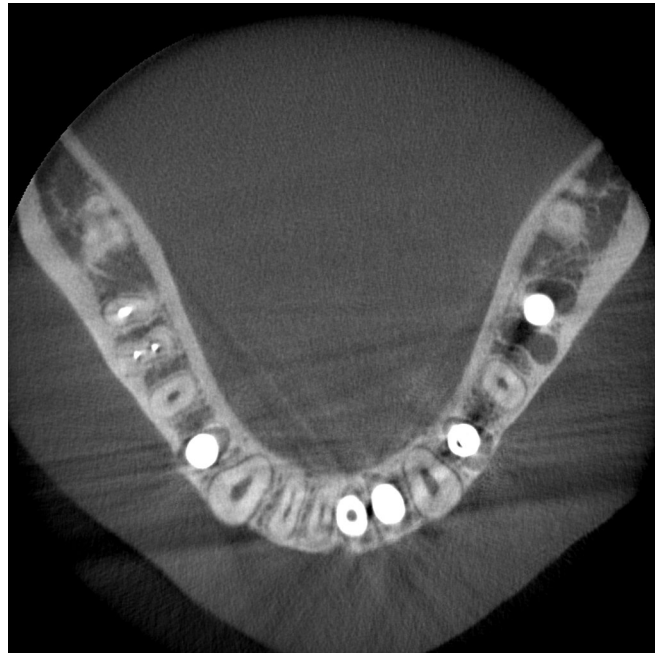

180° Mode Image

## 360° & 180° Exposure Modes

Depending on the diagnostic purpose, the 360° mode can be used for greater detail or the 180° mode can be used for lower X-ray dose and a quicker exposure time.

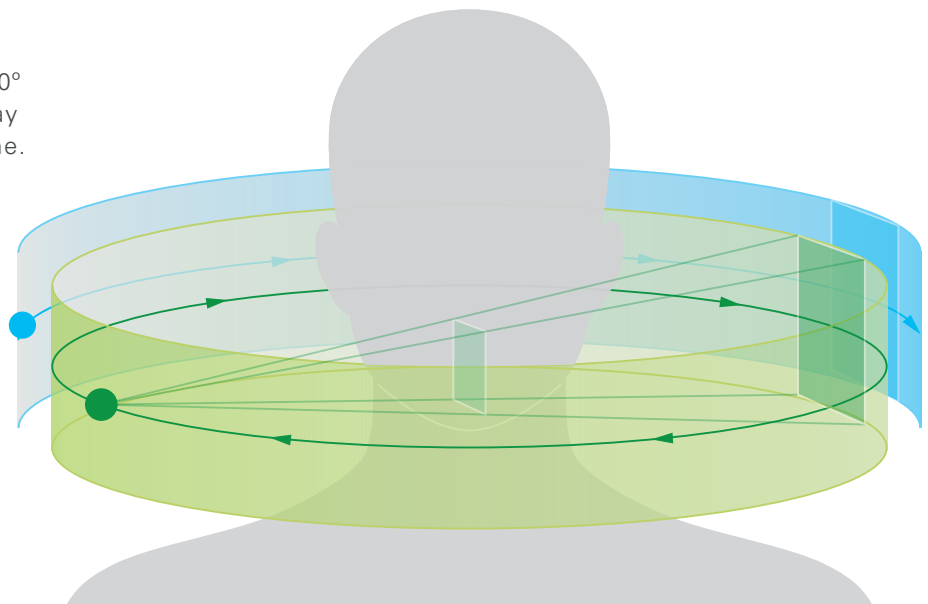



# CBCT Positioning with Scout

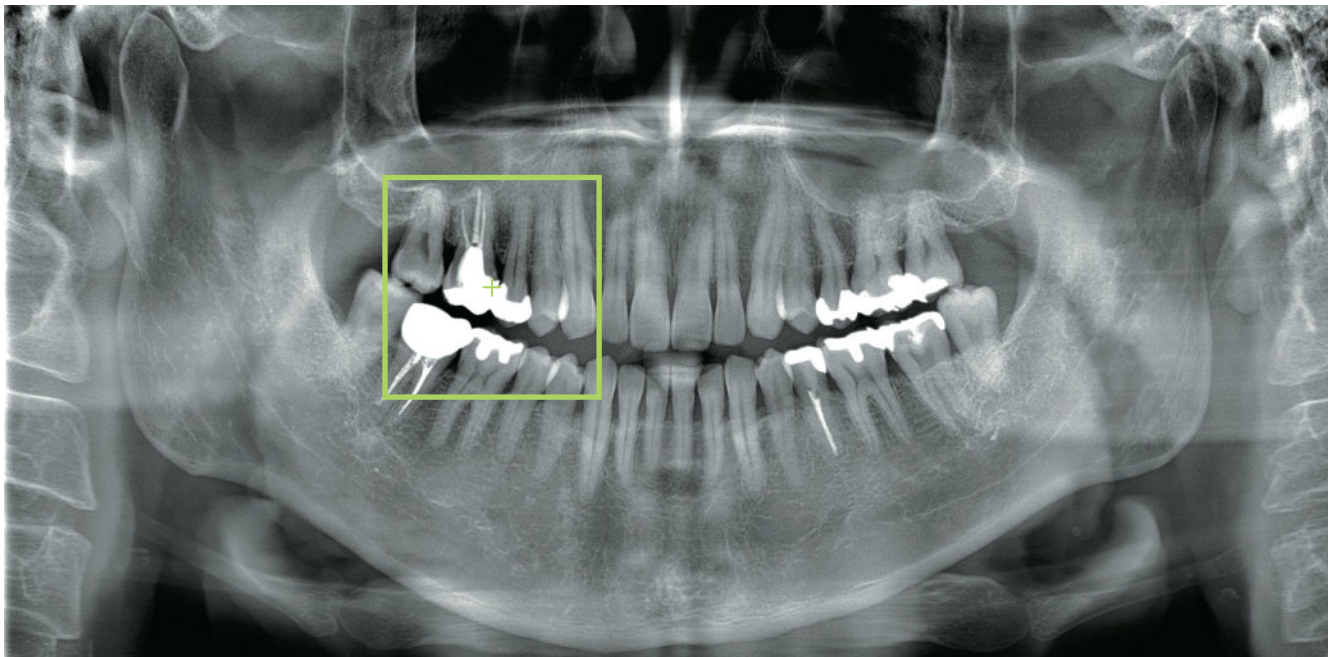

Panoramic Image



Axial Section Image

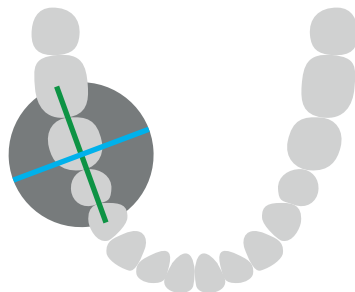

## Panoramic Scout

By specifying the region of interest in a panoramic image, positioning and exposure for a limited field CBCT is very simple. This reduces stress for the patient.

After taking a CBCT exposure, double click a cross mark on the panoramic image to display the CBCT data for that region.

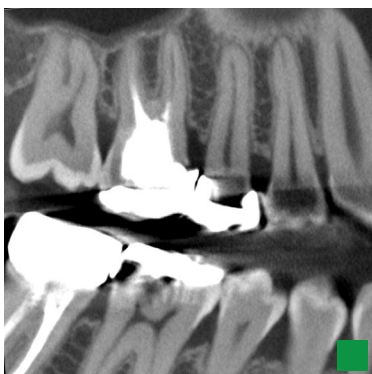

Sagittal Section Image

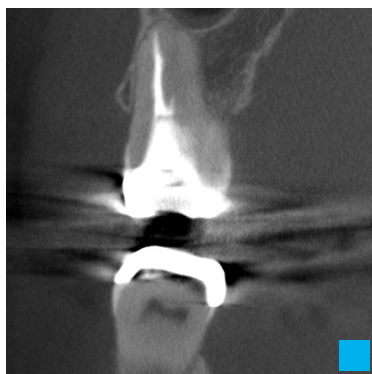

Frontal Section Image



## Two-direction Scout

The region of interest is specified by taking lateral and frontal scout images. These images are used to execute accurate positioning for a limited field CBCT exposure.

# Various Fields of View

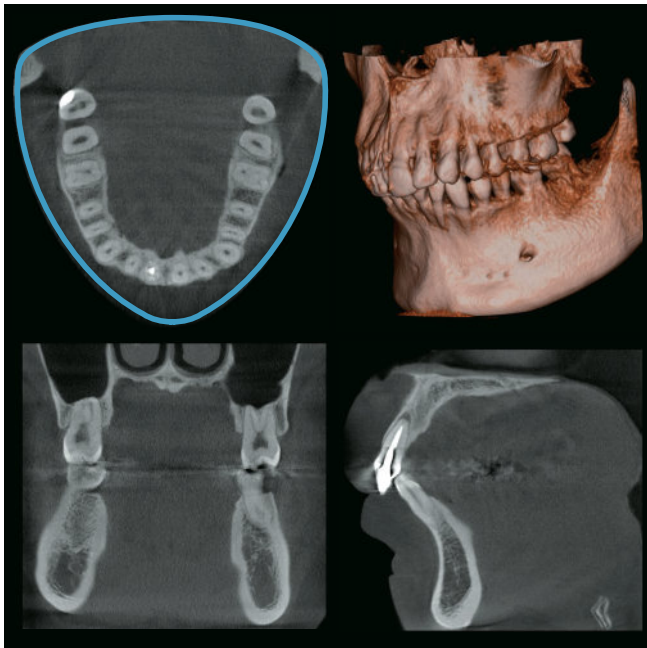

Dental Arch FOV (R 100 x H 80 mm)

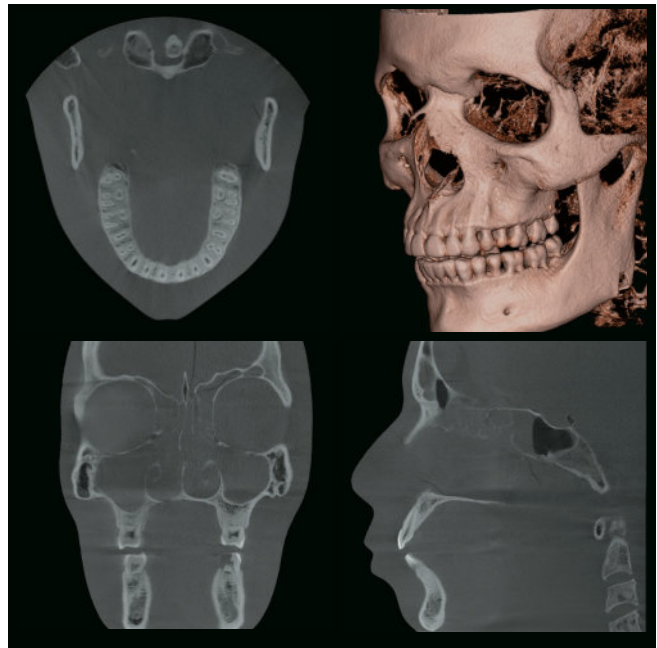

Ø 150 x H 140 mm

## Dental Arch FOV Function

A uniquely shaped field of view (FOV) with a Ø100 mm encompasses the entire dental arch. Imaging of the entire arch can be executed with less X-ray dose by excluding area outside the region of interest.

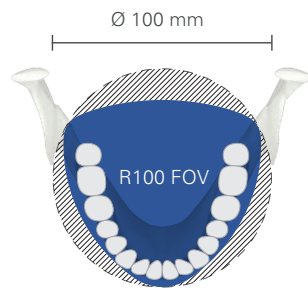

## Maximum FOV Ø150

The X800's largest field of view, Ø150, allows a scan of the entire jaw region which is useful for orthodontic, TMJ and occlusal observation and treatment.

## Dose Reduction Function

Patient X-ray dose can be reduced by as much as 40%\* by lowering the amount of radiation used for areas with greater transparency.

\* Compared to when the Dose Reduction function is turned OFF.

FOV	Voxel Size	180° Mode	360° Mode	F40	R100	F150
<b>Ø 40 x H 40 High Res</b>	<b>0.080 mm</b>					
Ø 40 x H 40	0.125 mm	○	○	○	○	○
Ø 40 x H 80						
Ø 80 x H 40	0.125 mm	○	○	—	○	○
Ø 80 x H 50						
Ø 80 x H 80						
R 100 x H 40* <sup>1</sup>	0.125 mm	○	—	—	○	○
R 100 x H 50* <sup>1</sup>						
R 100 x H 80* <sup>1</sup>						
Ø 150 x H 50* <sup>2</sup>	0.320 mm	—	○	—	—	○
Ø 150 x H 75* <sup>2</sup>						
Ø 150 x H 140* <sup>3</sup>						

\*<sup>1</sup> R100: Dental Arch FOV (Ø100 equivalent) \*<sup>2</sup> Data used equivalent to 180 degree exposure.

\*<sup>3</sup> Two 360 degree exposures, top and bottom. Data used equivalent to 180 degree exposure.

## Zoom Reconstruction Function\*\*

For the first time, Morita's zoom reconstruction feature is available on a multi-functional unit. After taking an image with a voxel size of 125 µm, reconstruction can be repeated for a higher resolution of 80 µm voxel size without retaking the exposure.

\*\* This function cannot be used for Ø150 exposure.



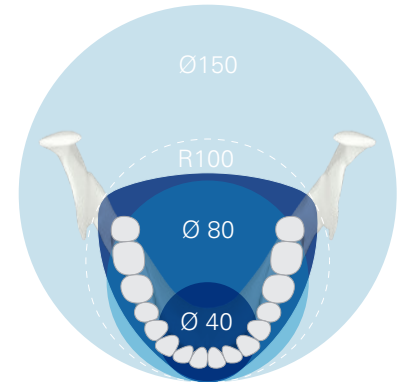
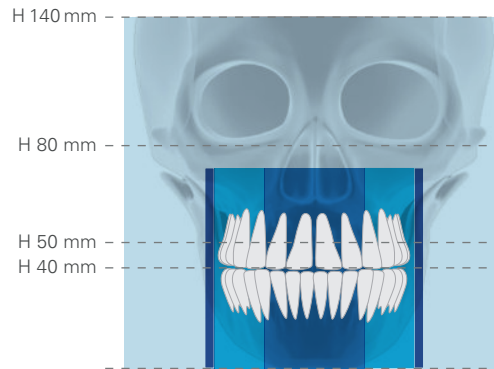

**Multiple Fields of View**

Veraview X800 offers a total of 11 different FOVs from Ø40 up to Ø150. This unit is appropriate for a variety of specialties and applications such as orthodontics, implantology, periodontics, and endodontics.

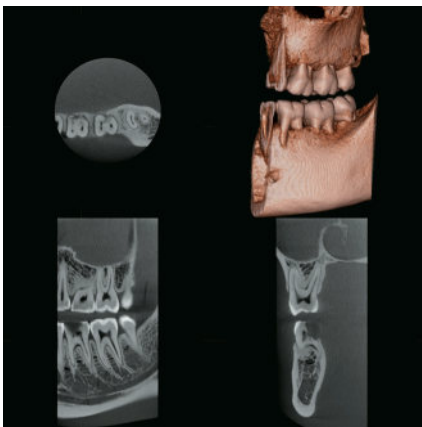

Ø 40 x H 80 mm

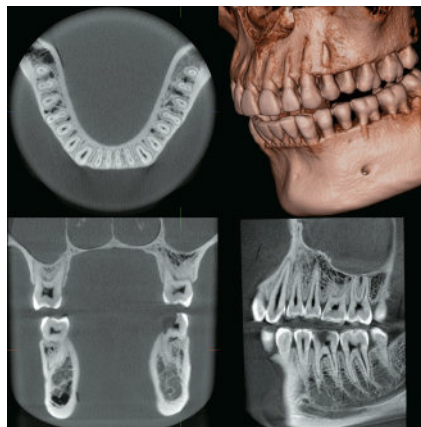

Ø 80 x H 80 mm

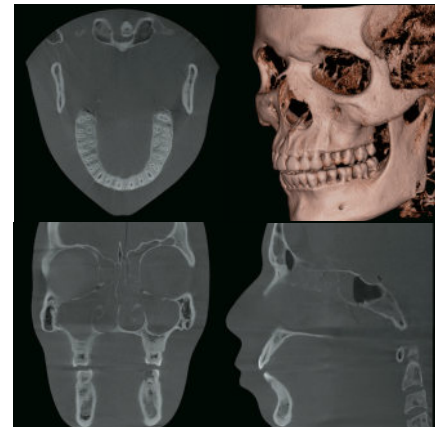

Ø 150 x H 140 mm

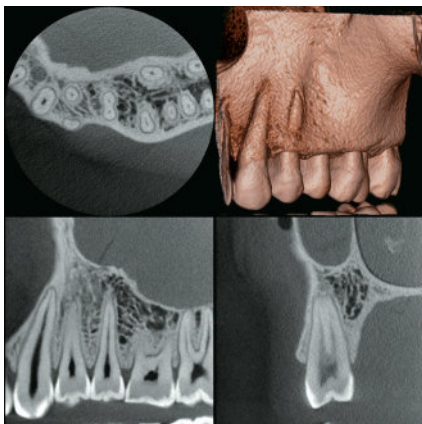

Ø 40 x H 40 mm

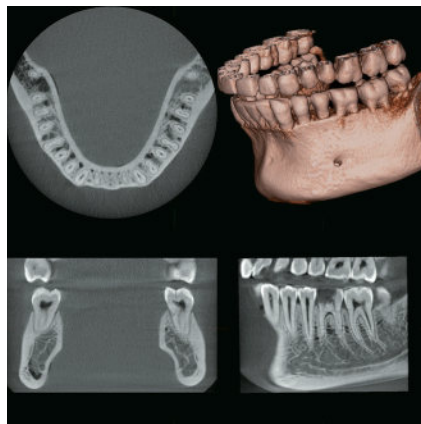

Ø 80 x H 50 mm

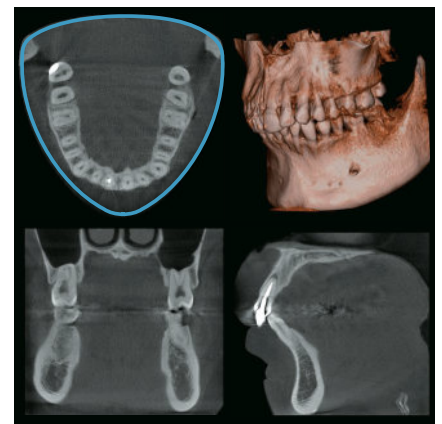

Dental Arch FOV (R 100 x H 80 mm)

# Panoramic

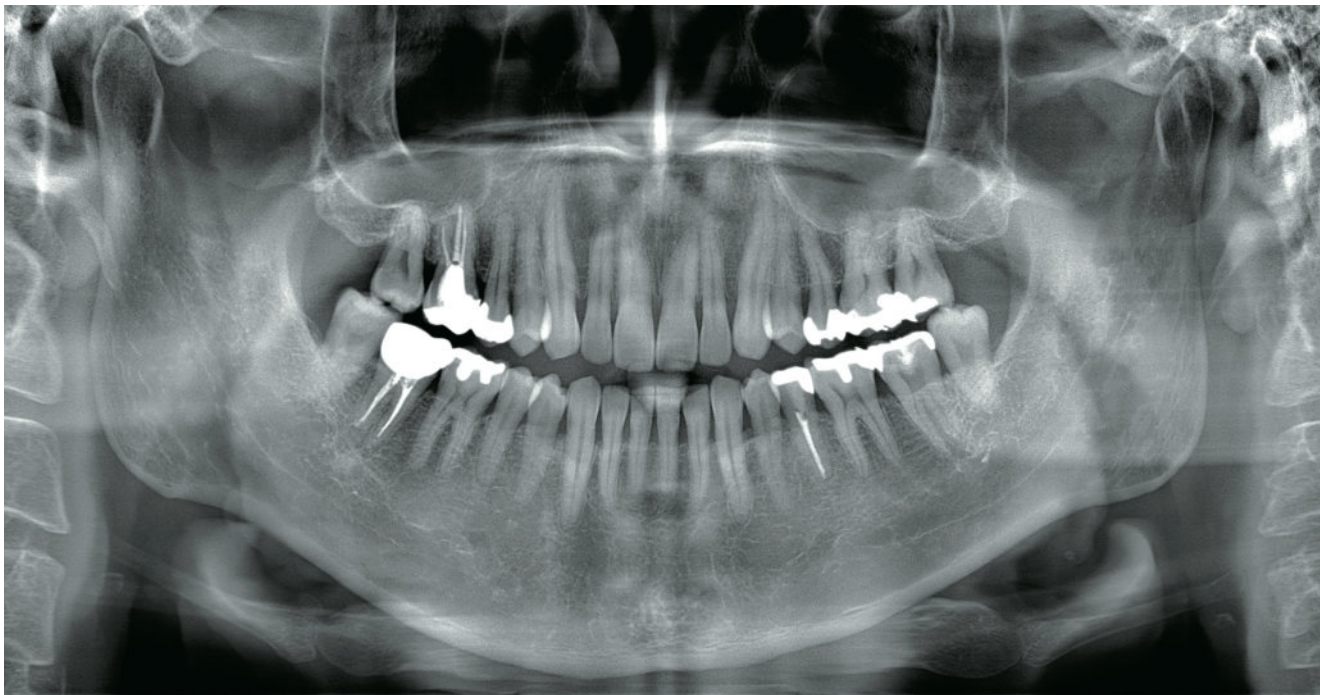

AFP + AGS + AIE-HD

## Panoramic Image - Consistent Image Quality and Clarity

Various functions such as AFP (Adaptive Focal Point), AGS (Adaptive Gray Scale), and AIE-HD (Auto Image Enhancement – High Definition) can be combined to obtain images uniformly in focus with the areas of interest clearly observable. Additionally, the clinician may choose between three types of image-layer orbits to suit the individual patient's dentition.

## AFP (Adaptive Focal Point)

1. Images obtained depending on the image layer

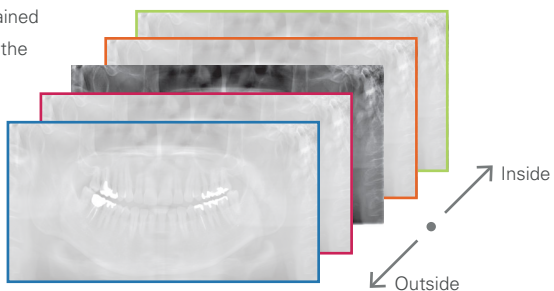

2. Select the area that is in focus and make the entire image in focus.

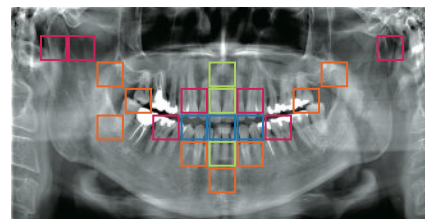

**AFP (Adaptive Focal Point)**

This function enhances the focus and clarity for the entire scan obtained by the image-layer exposure. Everything in the image from the root apex to the incisor region is in focus.

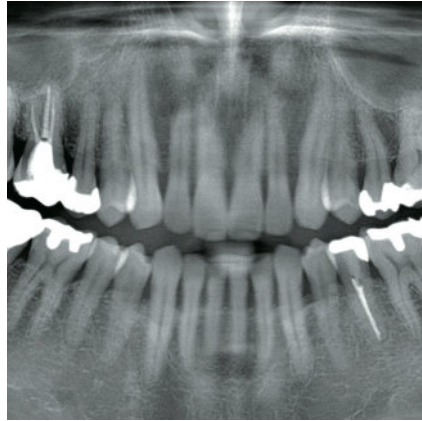

AIE-HD (AFP OFF)



AIE-HD (AFP ON)

**AGS (Adaptive Gray Scale)**

AGS automatically adjusts density to make the whole panoramic image clearly observable including the dental arch, jaw bone, TMJ etc.

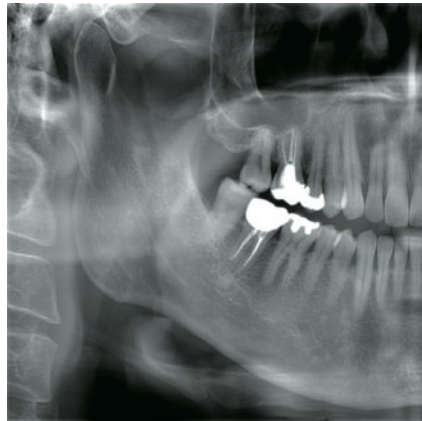

AFP + AIE-HD (AGS OFF)



AFP + AIE-HD (AGS ON)

**AIE-HD (Auto Image Enhancement)**

This function optimizes panoramic image processing and makes every detail sharp and clear.

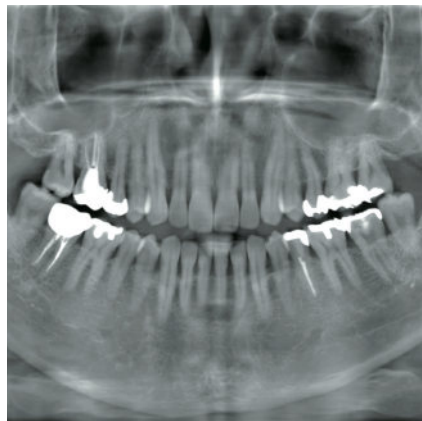

AFP + AGS (AIE-HD OFF)



AFP + AGS (AIE-HD ON)



# Panoramic

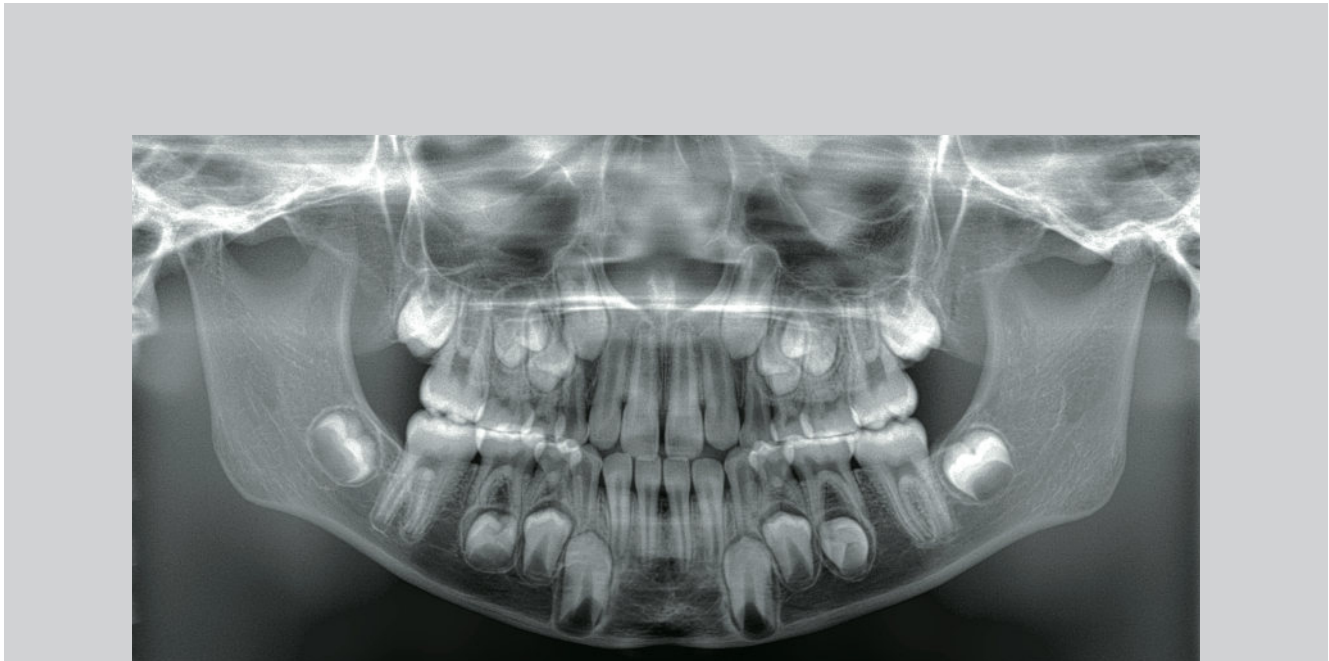

## Pediatric Panoramic

For children's smaller jaws, the range of exposure is more narrow to reduce X-ray dose.

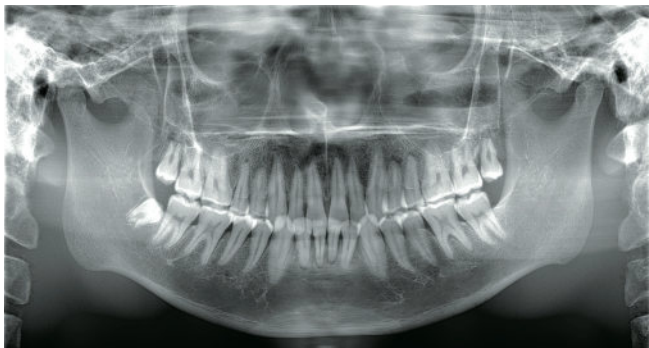

## Orthographic Panoramic

The X-ray beam intersects the dental arch perpendicularly to reduce overlapping of neighboring teeth.

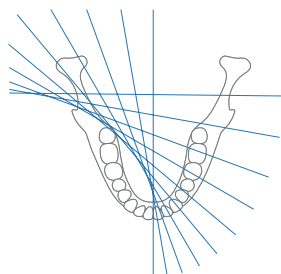

## Shadowless Panoramic

This function reduces the shadow caused by the mandibular ramus on the opposite side.

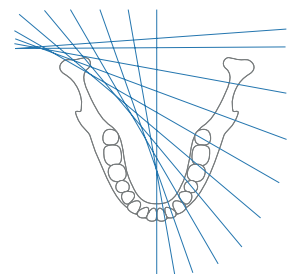

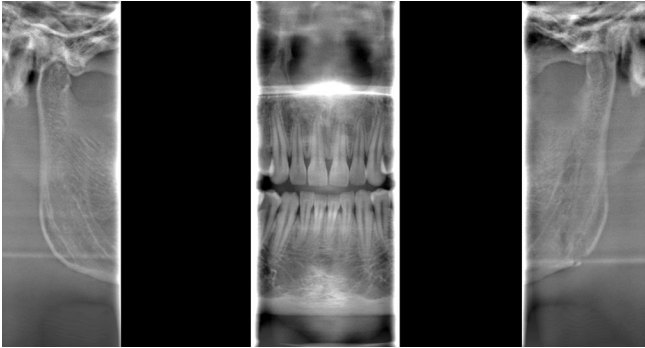

### Partial Panoramic

If a complete panoramic image is not needed, a panoramic of only a specified region can be taken. By excluding parts of the dental arch, X-ray dose is reduced.

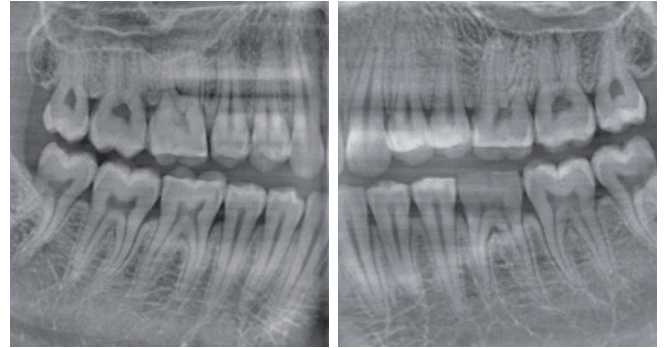

### Bite-wing Exposure

This exposure is useful for prosthetics and diagnosis of mild periodontitis or caries in the proximal spaces of premolars and molars.

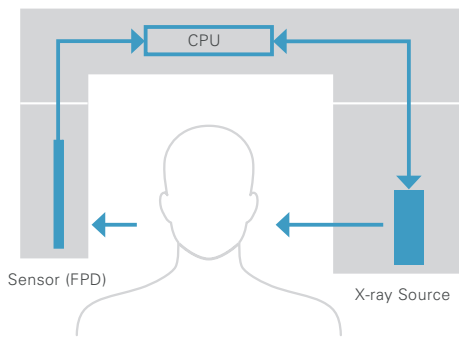

### DDAE (Digital Direct Auto Exposure)

During the exposure the flat panel detector detects X-ray transparency in real time and then controls the amount of X-rays emitted to create images with a much better dynamic range.

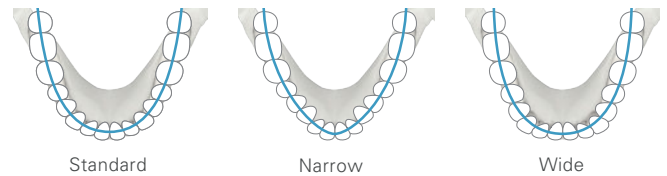

### Image layer orbit matches dental arch

Three types of image-layer orbits are available to suit the individual patient's dentition.



# Cephalometric

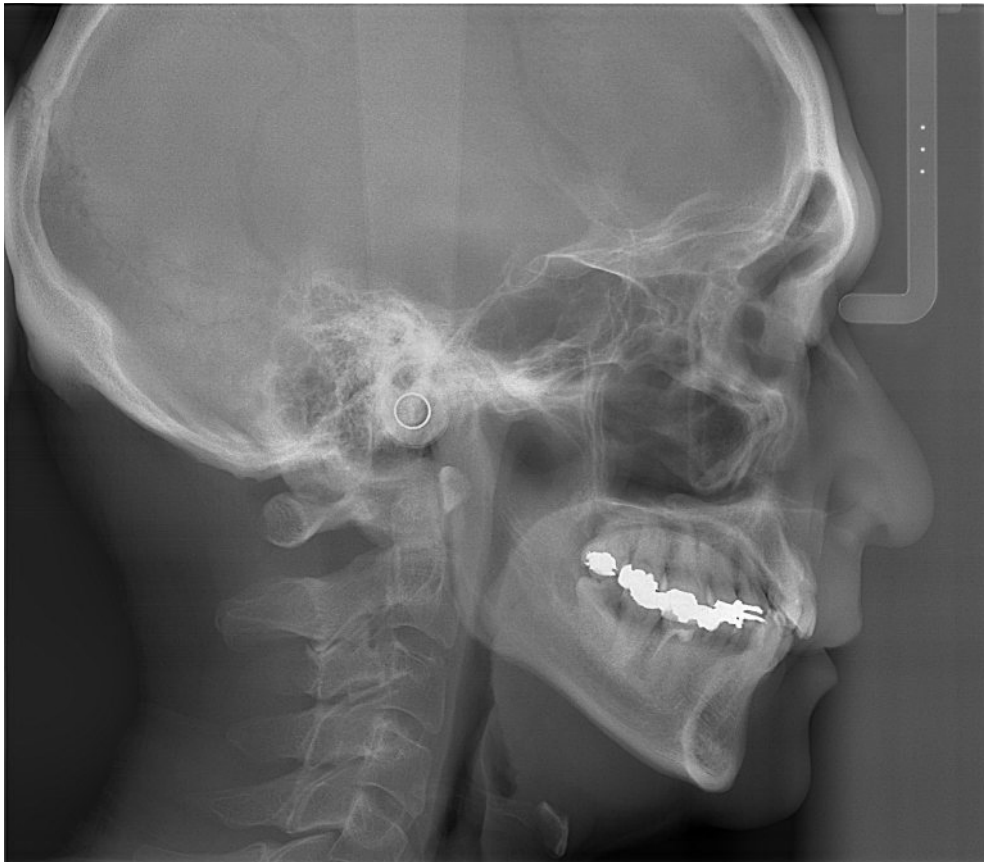

## High Quality Cephalometric

100 KV tube voltage produces high quality cephalometric images, while high resolution of 96  $\mu\text{m}$  makes it easy to find trace points. Additionally, the soft tissue filter can be adjusted in increments of 5mm to match the size of the patient.



## Partial Cephalometric

Three regions can be excluded if not needed for evaluation. This reduces the patient's X-ray dose.

# Face-to-Face Design



## Face-to-Face Positioning

Laser beam positioning is more accurate if you have good communication with the patient.

## Wheelchair Compatible

The chin rest can be lowered to 865 mm (Short Column) to accommodate patients in wheelchairs.

## Control Panel

The control panel moves freely so that it can be used from the front, or side, for improved access during patient positioning.



## User Interface

The intuitive touch panel is designed for easy operation.

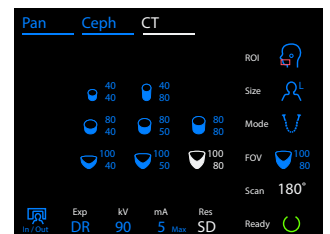
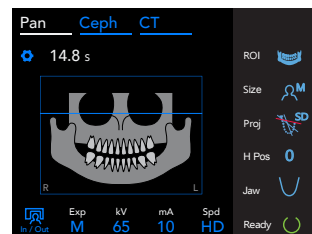
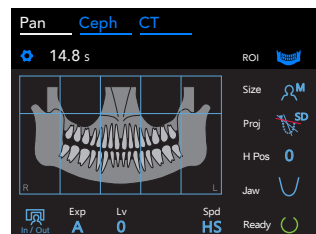
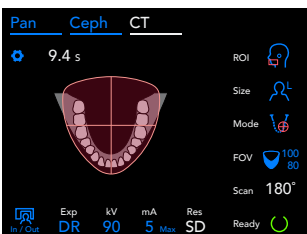

# Network System in Clinic

## **i-Dixel WEB**

CBCT and 2D images can be displayed on any PC or tablet computer using a conventional web browser without installing any special software, which is convenient and helpful for patient consultation.

## **i-Dixel conforms to the following DICOM3.0**

1. Modality worklist management service class
2. Storage service class
3. Modality performed procedure step service class
4. Print management service class

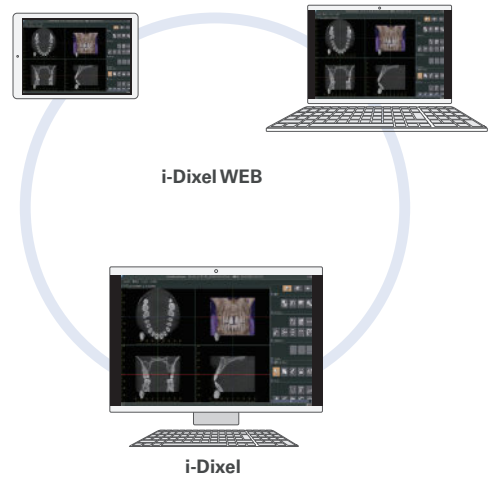

Panoramic / Cephalometric Small Base



Panoramic Large Base



Cephalometric Large Base

# Specifications

Name: Veraview X800  
 Model: X800  
 Order Selection: F40 / R100 / F150  
 Rating: AC 120V 60Hz  
 AC 220 / 230 / 240V 50 / 60Hz  
 Power Consumption: 2.0 kVA  
 Weight: Approx. 185 kg (approx. 220 kg with cephalometric)  
 Manufacturer: J. MORITA MFG. CORP.

X-ray Tube Voltage: 60 – 100 kV (depending on exposure mode)  
 X-ray Tube Current: 2 – 10 mA (depending on exposure mode)  
 Nominal Focal Spot: 0.5

Panoramic Exposures: High speed mode (standard panoramic) approx. 7.4 sec.  
 Fine Mode (standard panoramic) approx. 14.8 sec.

Panoramic Regions: Standard Panoramic (Standard, Orthographic, Jaw),  
 (consistent magnification) Pedodontic Panoramic (Standard, Orthographic, Jaw),  
 Maxillary Sinus Panoramic (Anterior, Posterior),  
 Quadruple TMJ, Partial Panoramic, Bite-wing Exposure  
 Distances measured on a panoramic image are not equal to the actual distances.

CBCT Exposure Time: Approx. 9.4 sec. (180°) / approx. 17.9 sec. (360°)  
 CBCT Exposure Regions: F40P / F40CP / F40C

- Ø40 x H40, Ø40 x H80
- R100P / R100CP / R100C
- Ø40 x H40, Ø40 x H80
- Ø80 x H40, Ø80 x H50, Ø80 x H80
- R100 x H40, R100 x H50, R100 x H80
- F150P / F150CP / F150C
- Ø40 x H40, Ø40 x H80
- Ø80 x H40, Ø80 x H50, Ø80 x H80
- R100 x H40, R100 x H50, R100 x H80
- Ø150 x H50, Ø150 x H75, Ø150 x H140

Cephalometric Exposures: F40CP / F100CP  
 Direction and Size: LA 220 x 250, PA 220 x 200 mm

Wear protective aprons and coverings as necessary during X-ray exposure.  
 The unit must be fixed to the floor and wall when installed.  
 If minimal layout dimensions are used, there may be very little space to move around inside the booth.

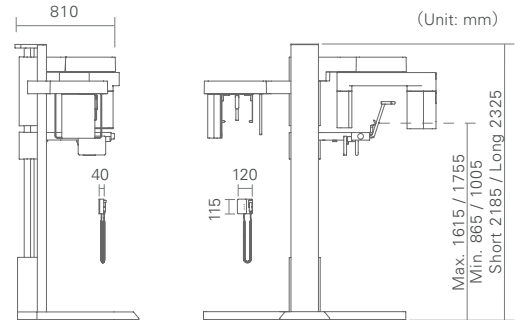

X800 - F40CP / R100CP  
 (Pan / Ceph / CBCT Exposure)

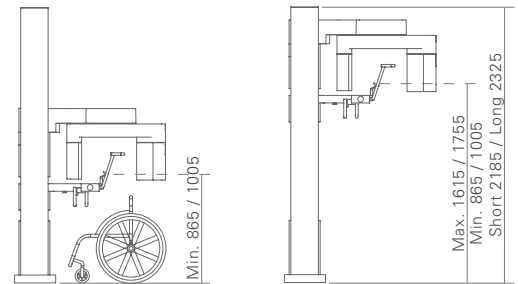

X800 - F40P / R100P  
 (Pan / CBCT Exposure)

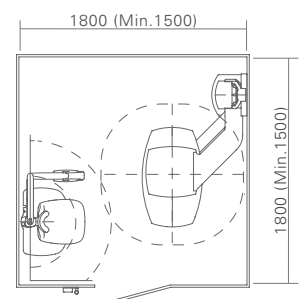
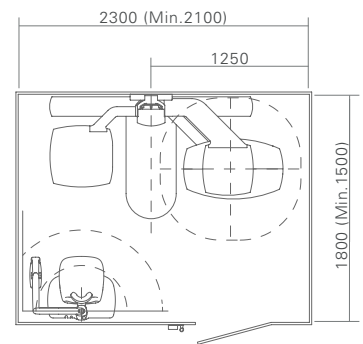



Development and Manufacturing

**J. MORITA MFG. CORP**

680 Higashihama Minami-cho, Fushimi-ku,  
Kyoto 612-8533, Japan  
T +81. (0)75. 611 2141, F +81. (0)75. 622 4595

**Morita Global Website**

[www.morita.com](http://www.morita.com)

Distribution

**J. Morita Corporation**

3-33-18 Tarumi-cho, Suita-shi, Osaka 564-8650, Japan  
T +81. (0)6. 6380 1521, F +81. (0)6. 6380 0585

**J. Morita USA, Inc.**

9 Mason, Irvine CA 92618, USA  
T +1. 949. 581 9600, F +1. 949. 581 8811

**J. Morita Europe GmbH**

Justus-von-Liebig-Strasse 27a, 63128 Dietzenbach, Germany  
T +49. (0)6074. 836 0, F +49. (0)6074. 836 299

**Morita Dental Asia Pte. Ltd.**

3 Science Park Drive,  
#01-05 The Franklin Singapore Science Park1, Singapore 118223  
T +65. 6779. 4795, F +65. 6777. 2279

**J. Morita Corporation Australia & New Zealand**

Suite 2.05, 247 Coward Street, Mascot NSW 2020, Australia  
T +61. (0)2. 9667 3555, F +61. (0)2. 9667 3577

**J. Morita Corporation Middle East**

4 Tag Al Roasaa, Apartment 902, Saba Pacha 21311 Alexandria, Egypt  
T +20. (0)3. 58 222 94, F +20. (0)3. 58 222 96

**J. Morita Corporation India**

Filix Office No.908, L.B.S. Marg, Opp. Asian Paints, Bhandup (West), Mumbai 400078, India  
T +91-22-2595-3482

**J. MORITA MFG. CORP Indonesia Representative Office**

28F, DBS Bank Tower, Jl. Prof. Dr. Satrio Kav. 3-5, Jakarta 12940, Indonesia  
T +62-21-2988-8332, F + 62-21-2988-8201

**Siamdent Co., Ltd.**

71/10 Mu 5, Thakham, Bangpakong, Chachuengsao 24130, Thailand  
T +66. 38. 573042, F +66. 38. 573043  
[www.siamdent.com](http://www.siamdent.com)

Catalog Design: f/p design, Germany

Subject to technical changes and errors.  
1703 Veraview X800 Br En

Diagnostic and Imaging Equipment

Treatment Units

Handpieces and Instruments

Endodontic System

Laser Equipment

Laboratory Devices

Educational and Training Systems

Auxiliaries